

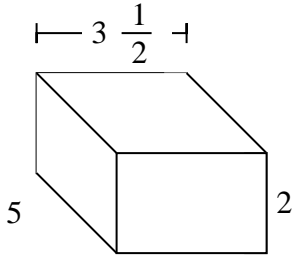

Fill each rectangular prism with cubes to determine the volume. Each prism's unit is measured in cm (not to scale).

Ex)



1)

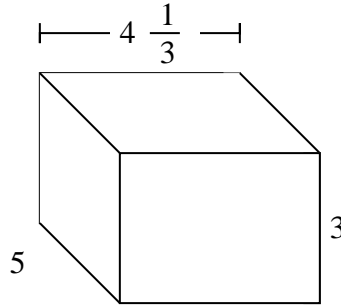

2)

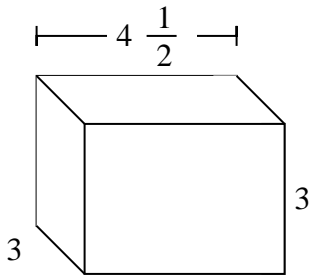

3)

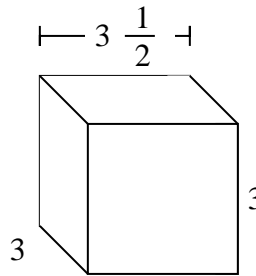

4)

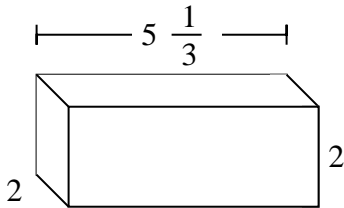

5)

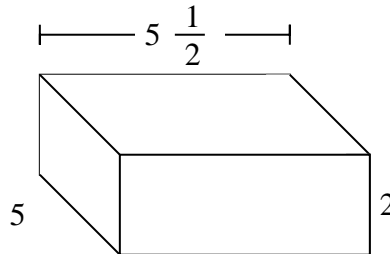

6)

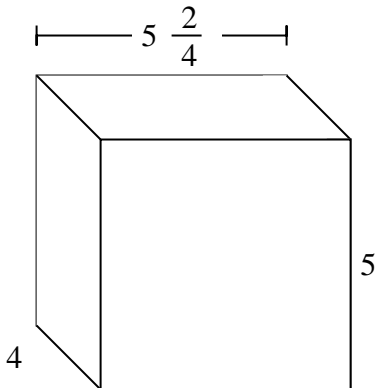

7)

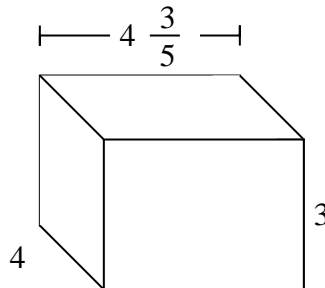
AnswersEx. 35 cm

1. _____

2. _____

3. _____

4. _____

5. _____

6. _____

7. _____

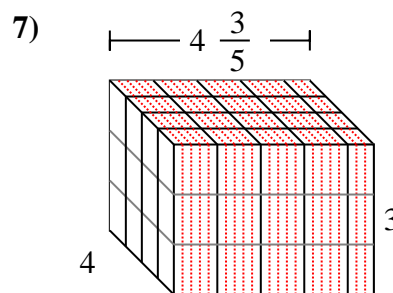
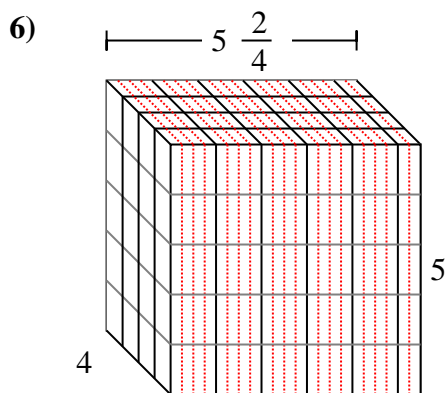
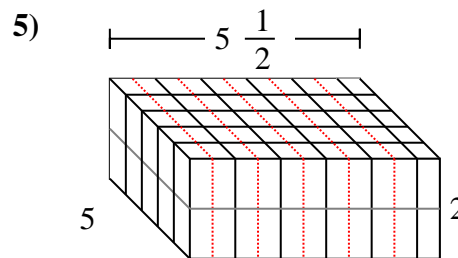
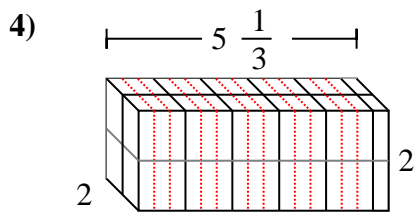
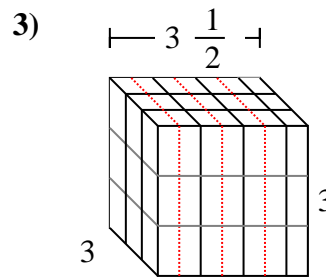
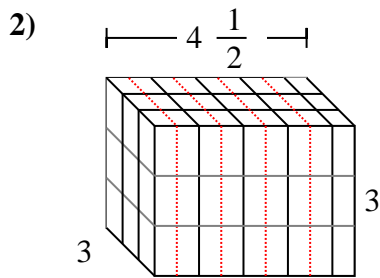
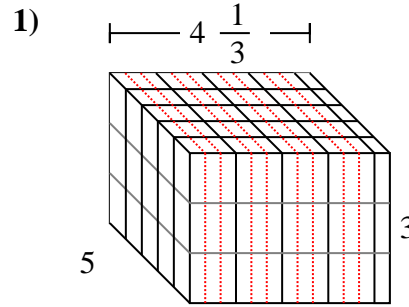
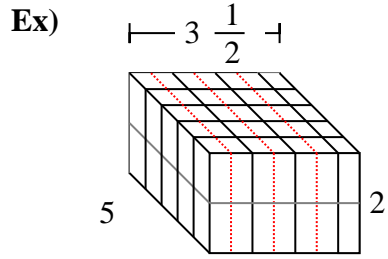

Fill each rectangular prism with cubes to determine the volume. Each prism's unit is measured in cm (not to scale).

**Answers**Ex. 35 cm1. 65 cm2. 40 1/2 cm3. 31 1/2 cm4. 21 1/3 cm5. 55 cm6. 110 cm7. 55 1/5 cm